



# T-28C exterior

eduard

32 421

1/32

detail set for KITTY HAWK 1/32 kit • sada detailů pro stavebnici KITTY HAWK 1/32

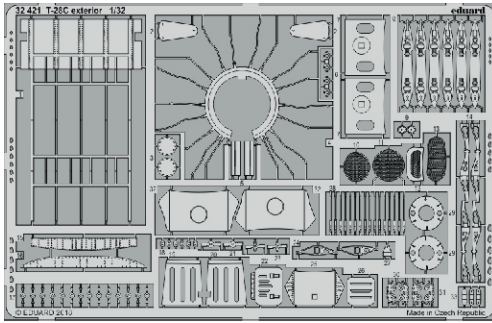

- APPLY EXPRESS MASK AND PAINT BEFORE GLUING  
POUŽIT EXPRESS MASK NABARVIT PŘED SLEPENÍM
  - SYMMETRICAL ASSEMBLY  
SYMETRICKÁ MONTÁŽ
  - REMOVE  
ODSTRANIT
  - GRIND  
OBROUSIT
  - DRILL HOLE  
VRTAT OTVOR
  - COLORED ETCHED PARTS  
LEPTANÉ BAREVNÉ DÍLY
  - ETCHED PARTS  
LEPTANÉ NEBAREVNÉ DÍLY
  - ORIGINAL KIT PARTS  
PŮVODNÍ DÍLY STAVEBNICE
- BEND  
OHNOUT
  - OPTION  
VOLBA
  - REPLACE  
NAHRADIT

ORIGINAL KIT PARTS  
PŮVODNÍ DÍLY STAVEBNICE

PHOTO-ETCHED PARTS  
LEPTANÉ DÍLY

PARTS TO BE REMOVED  
DÍLY K ODSTRANĚNÍ

FILL  
TMELIT

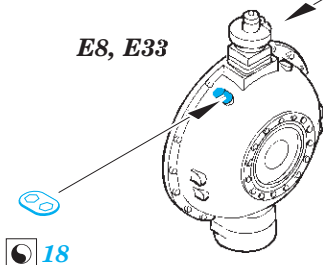
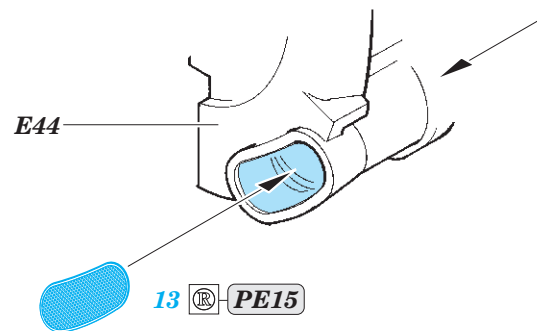
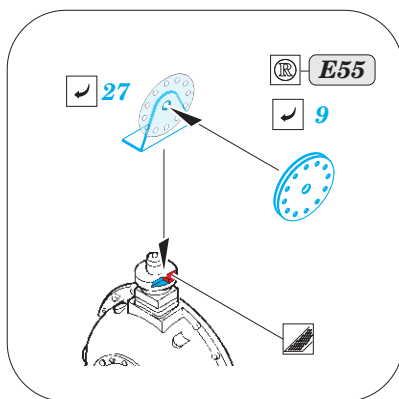
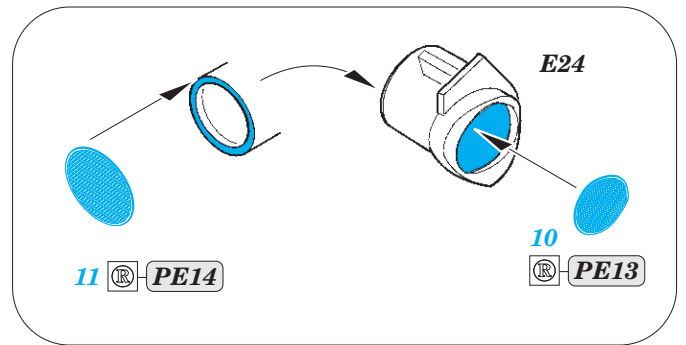
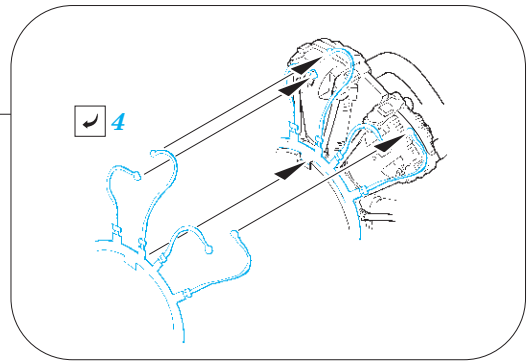
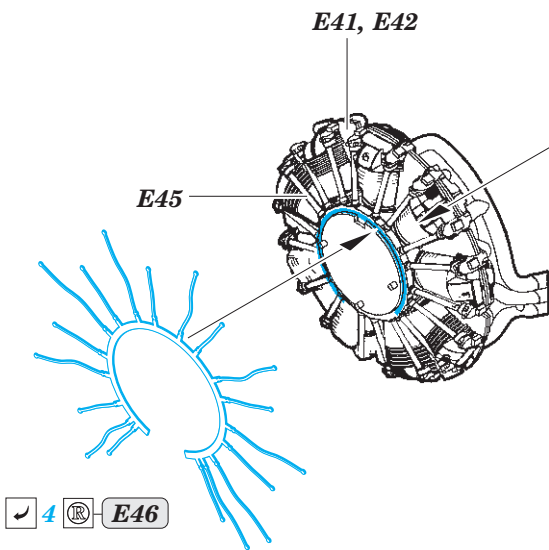

F25, F26  
F23, F24

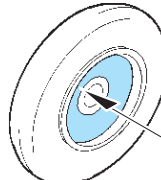

29

F14 F16



30 31

31 30

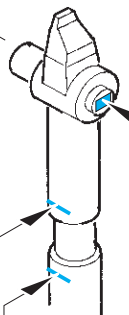

6

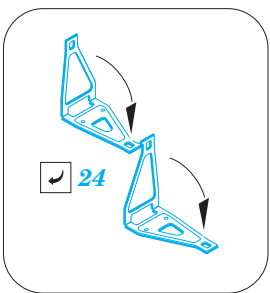

24

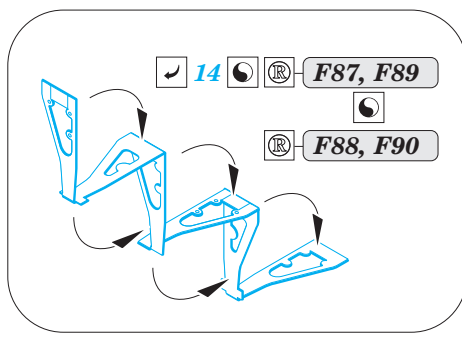

14 F87, F89

F88, F90

F60 F59

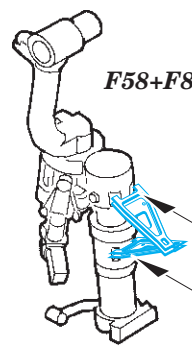

F58+F83

24

F95+F96

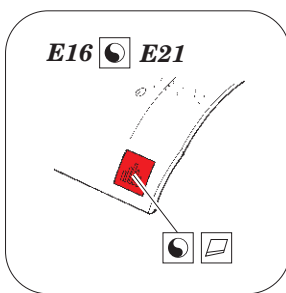

E16 E21

26



E16

3 3

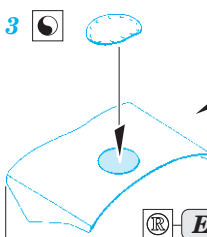

E52 / E53

32



7



33



E31 / E30

plastic  
Ø 1,0 x 4,5 mm

E21

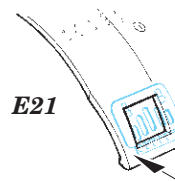

22



19 20

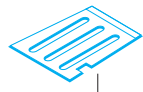

E16 E21

5



E16 E21

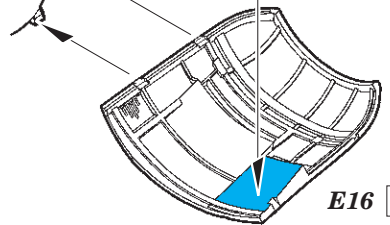

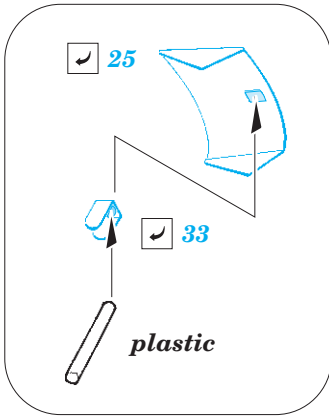

plastic  
Ø 1,0 x 3,5 mm  
E29

