



F4U-1 placards

eduard

32 795

1/32 scale detail set for Tamiya kit • sada detailů pro model 1/32 Tamiya

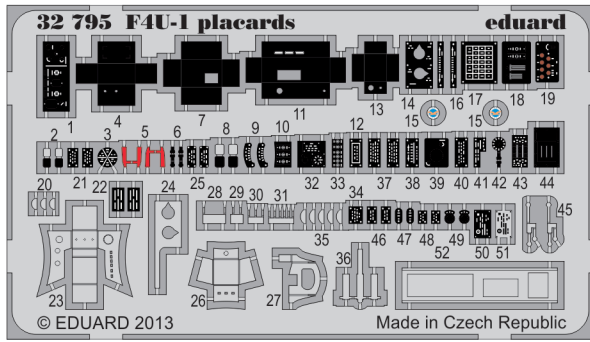

- APPLY EXPRESS MASK AND PAINT BEFORE GLUING
POUŽIT EXPRESS MASK NABARVIT PŘED SLEPENÍM
- SYMMETRICAL ASSEMBLY
SYMETRICKÁ MONTÁŽ
- REMOVE
ODSTRANIT
- GRIND
OBROUSIT
- DRILL HOLE
VRTAT OTVOR
- COLORED ETCHED PARTS
LEPTANÉ BAREVNÉ DÍLY
- BEND
OHNOUT
- OPTION
VOLBA
- REPLACE
NAHRADIT

■ ORIGINAL KIT PARTS
PŮVODNÍ DÍLY STAVEBNICE
 ■ PHOTO-ETCHED PARTS
LEPTANÉ DÍLY
 ■ PARTS TO BE REMOVED
DÍLY K ODSTRANĚNÍ
 ■ FILL
TMELIT

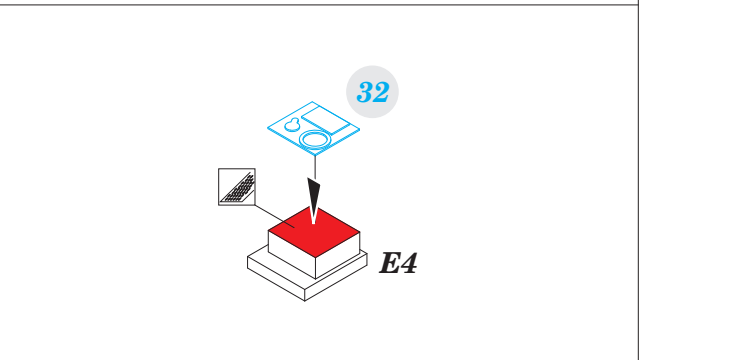
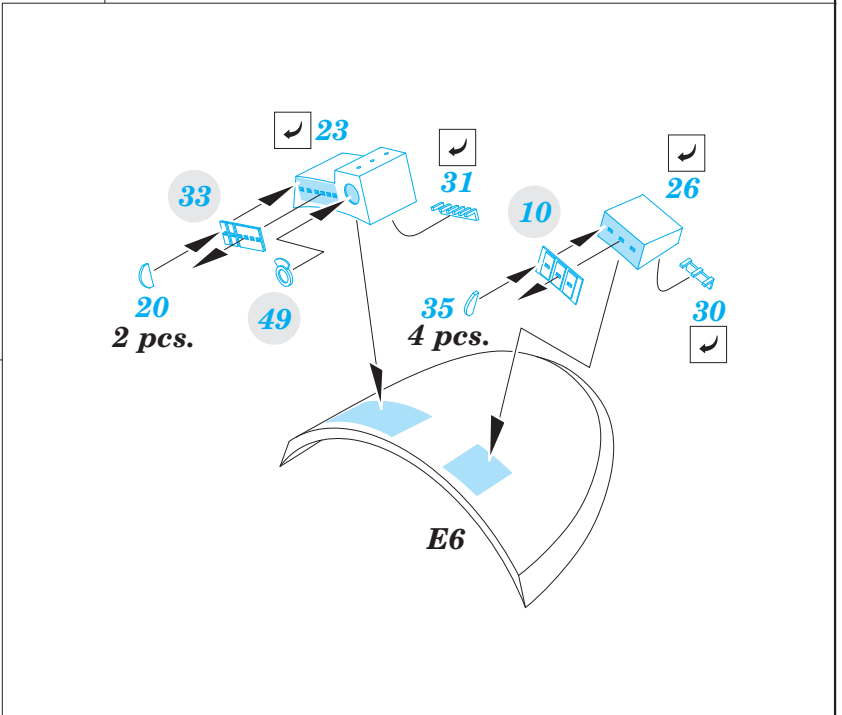
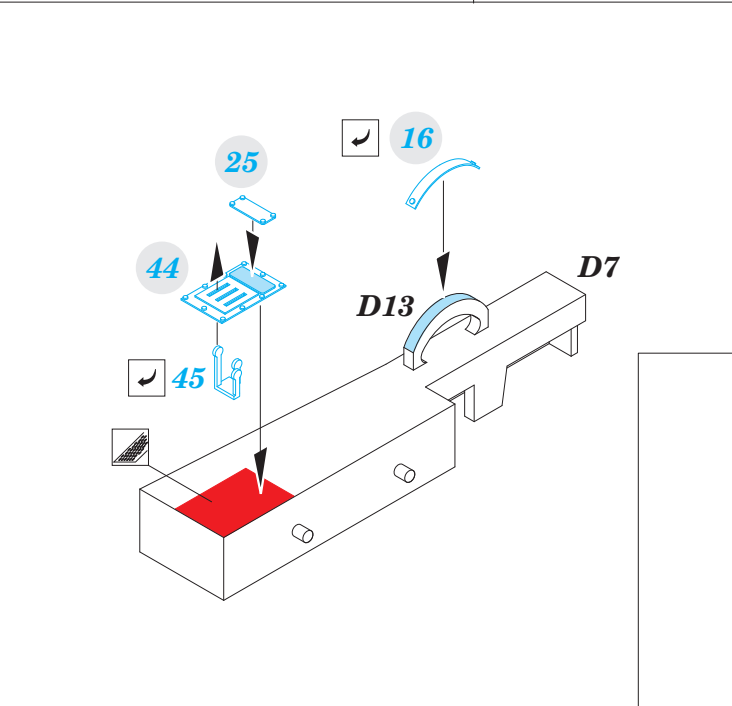
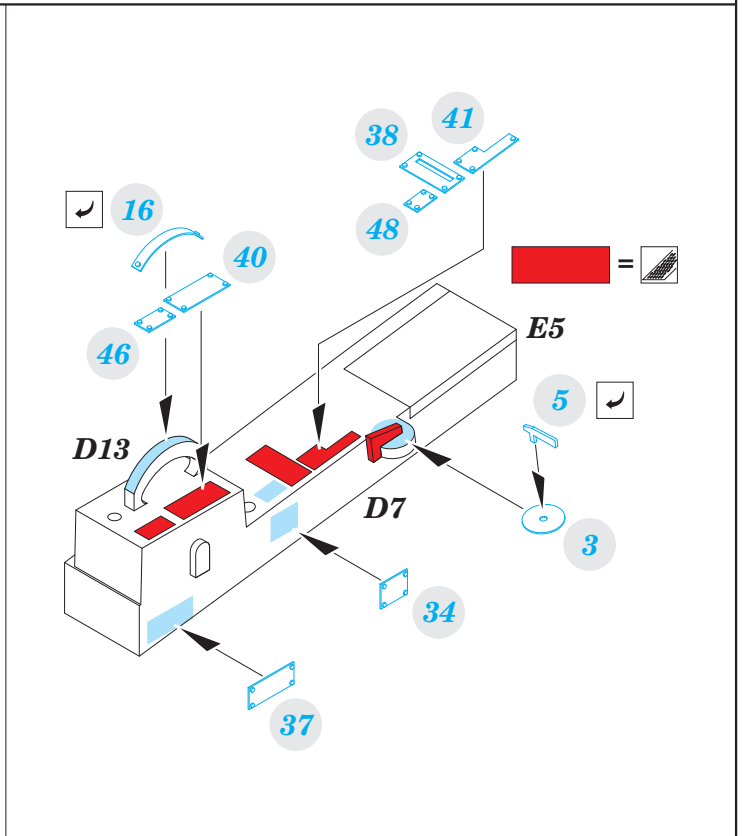
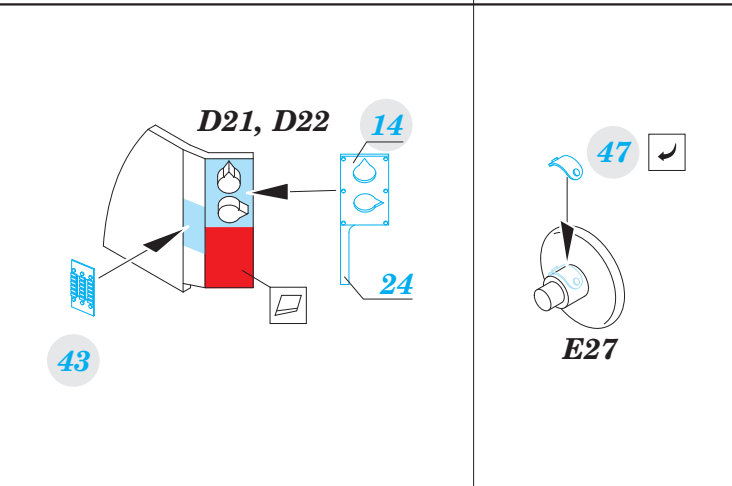

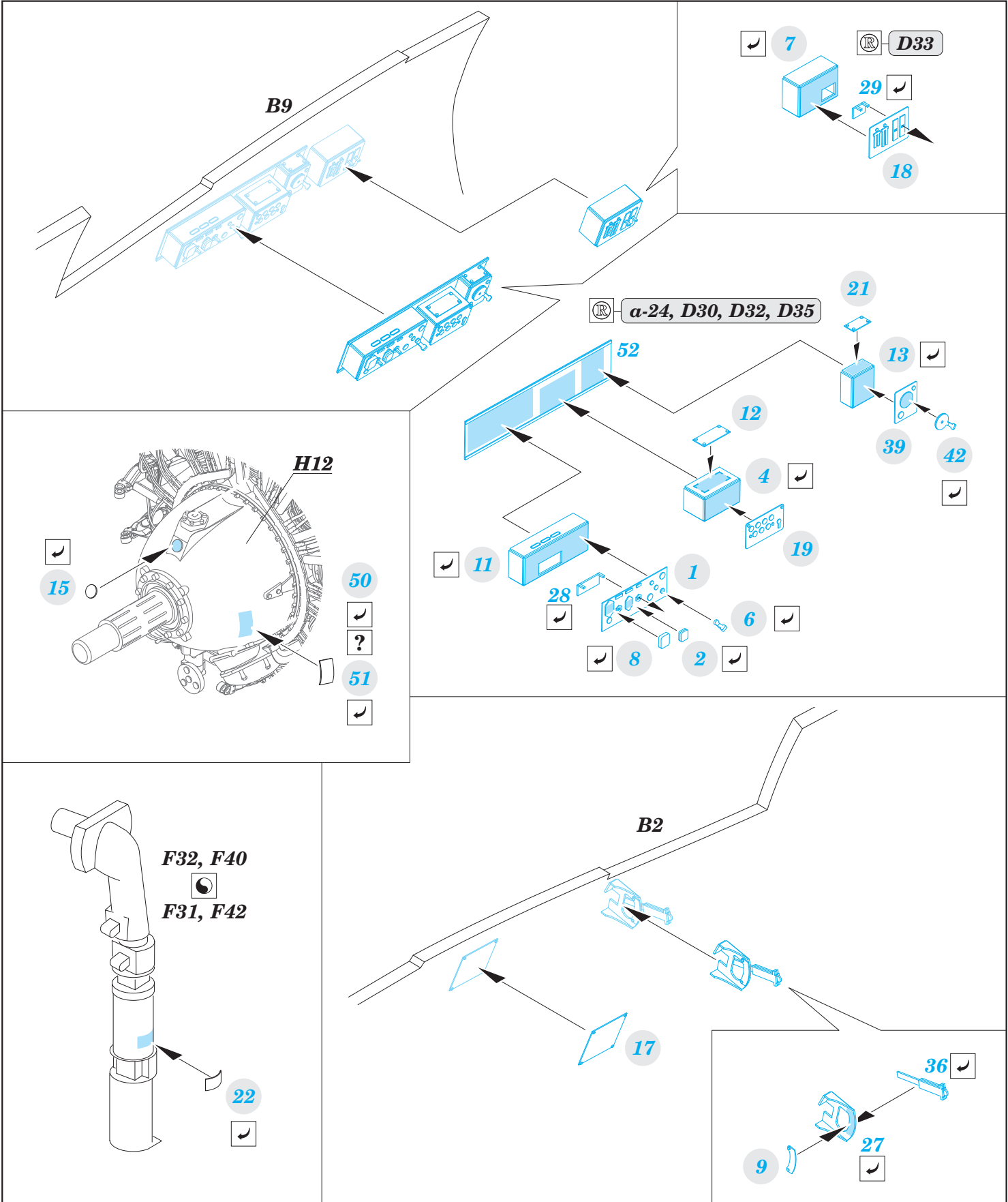

*For further detail sets look for **eduard** 32 781 F4U-1 Birdcage interior S.A. (not included in this set)*

*For further detail sets look for **eduard** 32 344 F4U-1 Birdcage exterior (not included in this set)*

*For further detail sets look for **eduard** 32 343 F4U-1 Birdcage engine (not included in this set)*