



F4U-1 Birdcage engine

1/32 scale detail set for TAMIYA kit • sada detailů pro model 1/32 TAMIYA

eduard

32 343

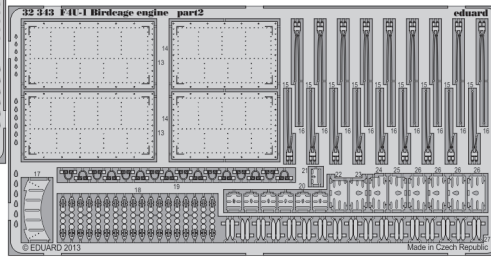
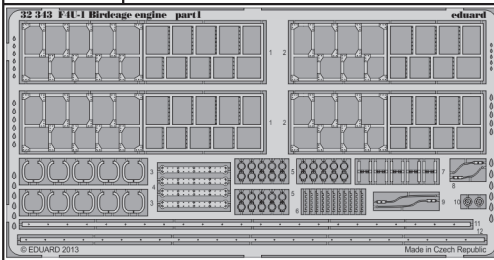

- APPLY EXPRESS MASK AND PAINT BEFORE GLUING
POUŽIT EXPRESS MASK NABARVIT PŘED SLEPENÍM
- SYMMETRICAL ASSEMBLY
SYMETRICKÁ MONTÁŽ
- REMOVE
ODSTRANIT
- GRIND
OBROUSIT
- DRILL HOLE
VRTAT OTVOR
- COLORED ETCHED PARTS
LEPTANÉ BAREVNÉ DÍLY
- BEND
OHNOUT
- OPTION
VOLBA
- REPLACE
NAHRADIT

ORIGINAL KIT PARTS
PŮVODNÍ DÍLY STAVEBNICE

PHOTO-ETCHED PARTS
LEPTANÉ DÍLY

PARTS TO BE REMOVED
DÍLY K ODSTRANĚNÍ

FILL
TMELIT

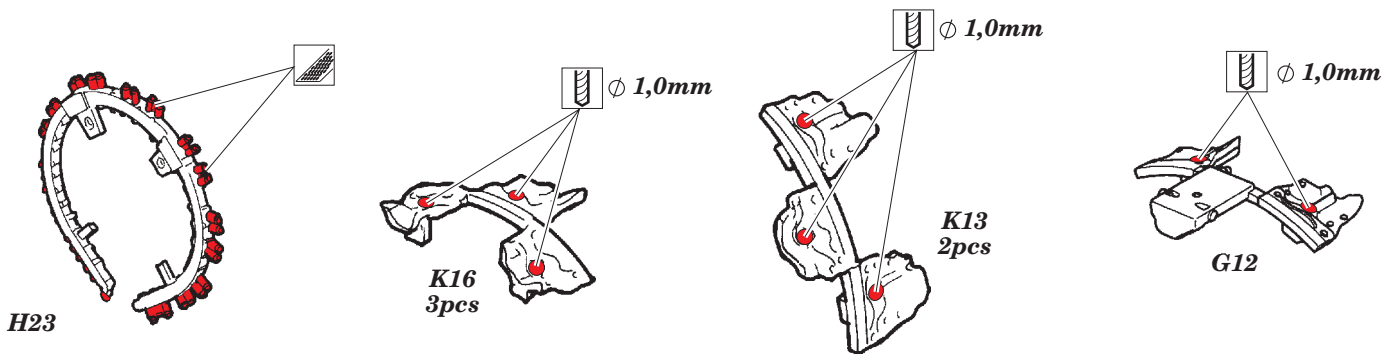

H23

K16
3pcs

K13
2pcs

G12

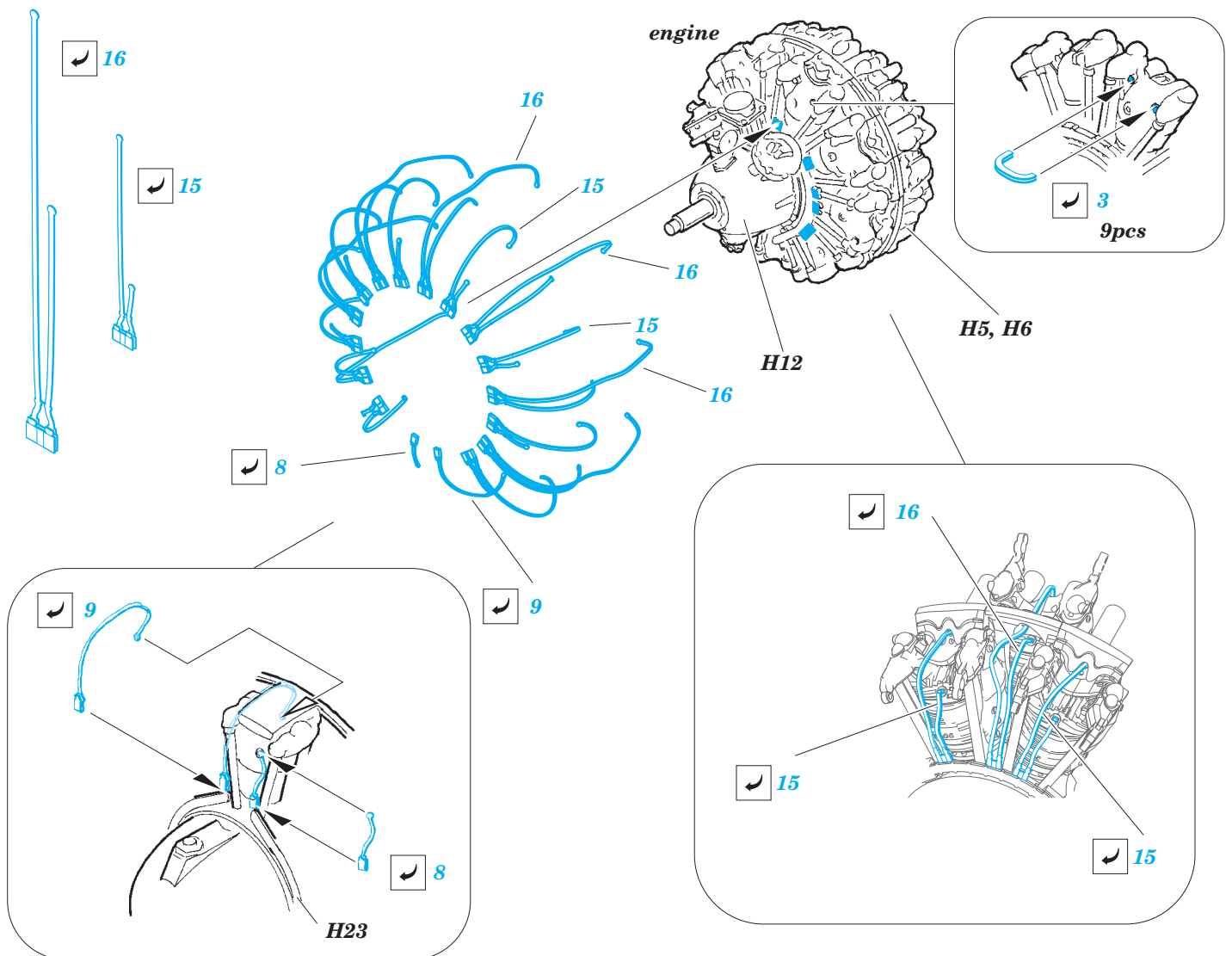

engine

H5, H6

H12

H23

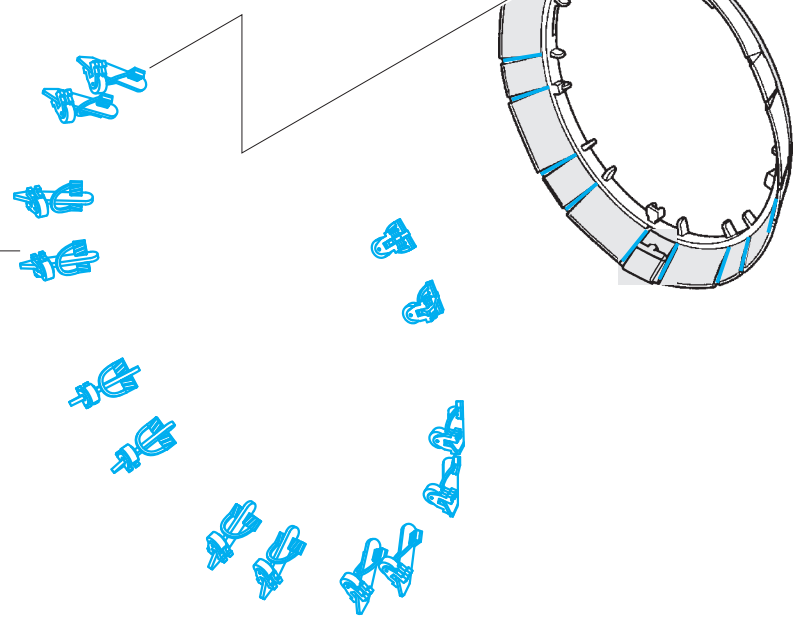
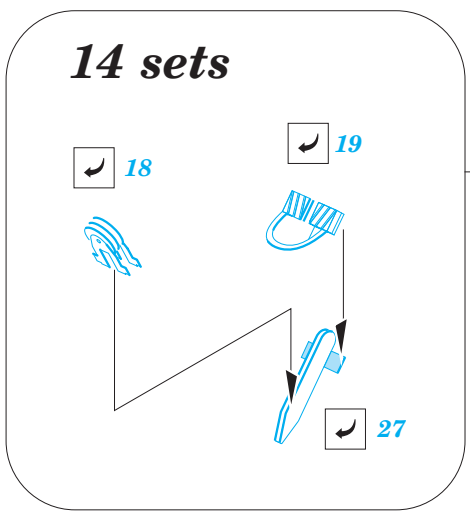
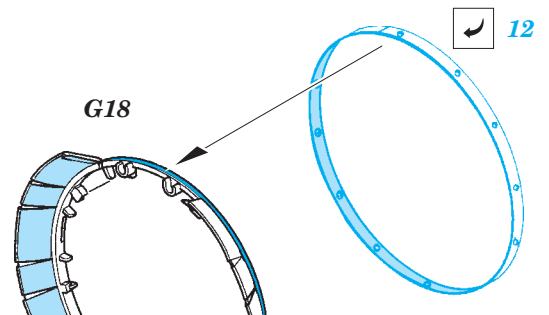
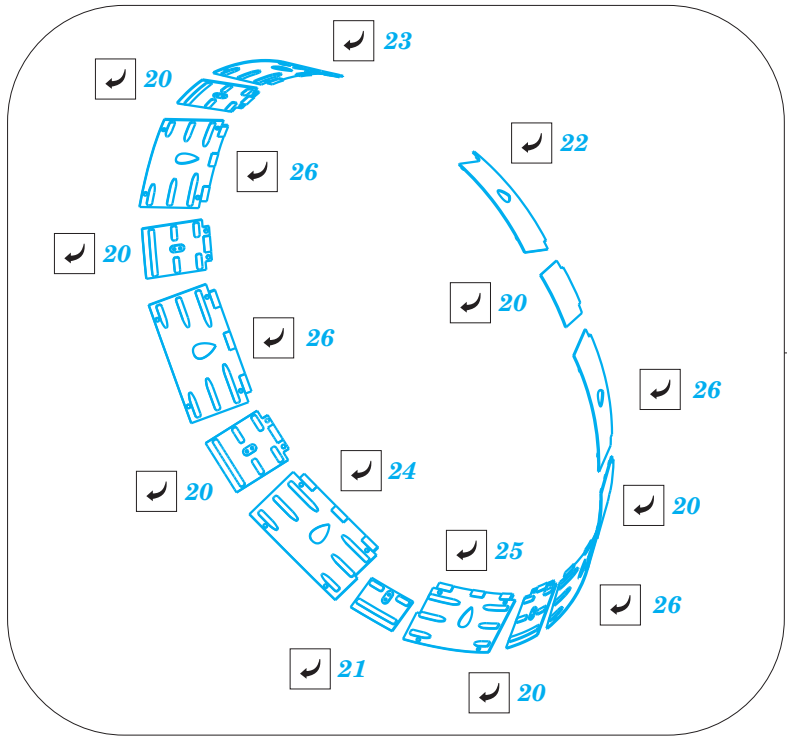
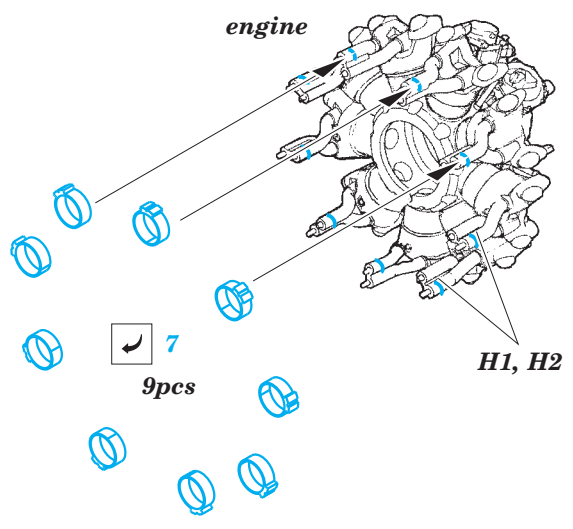
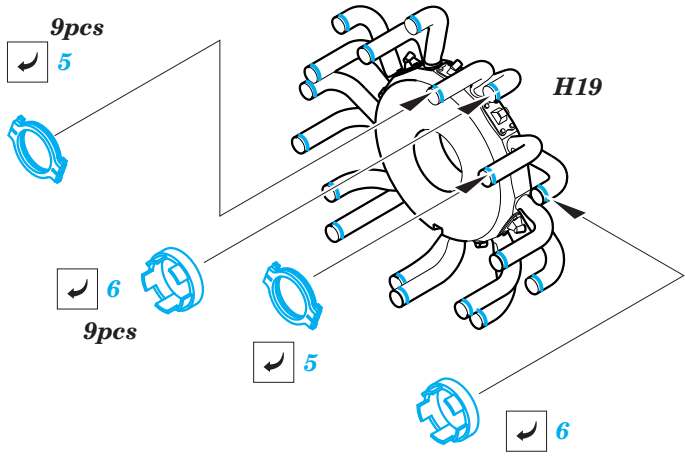

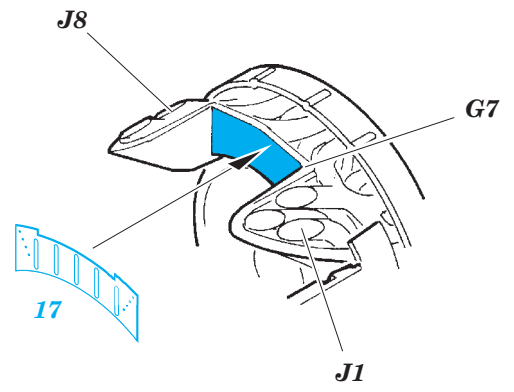
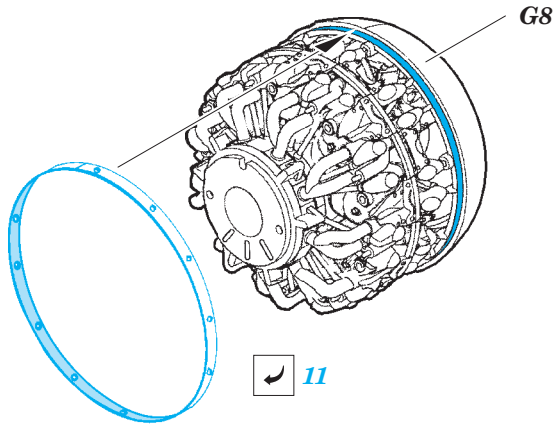

2 sets

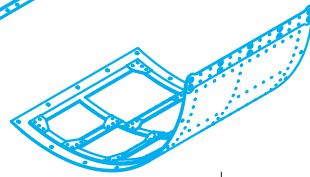
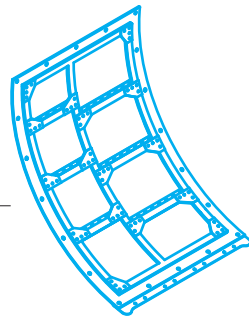
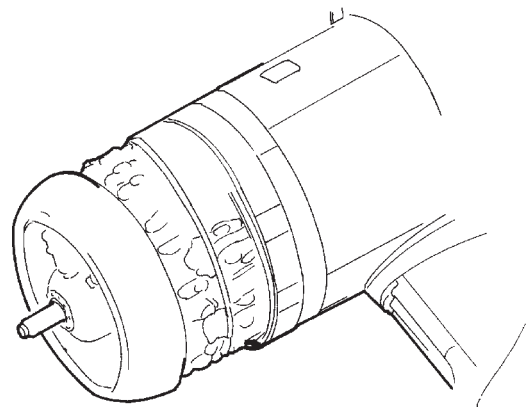
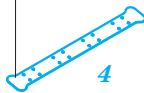
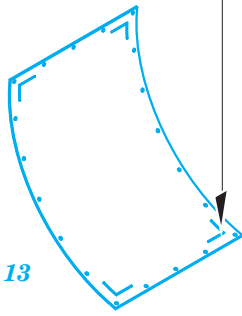
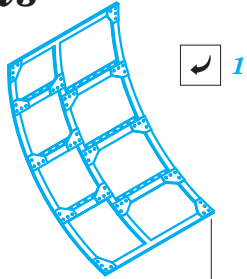

2 sets

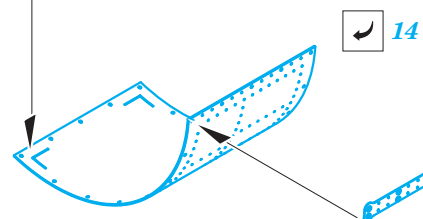
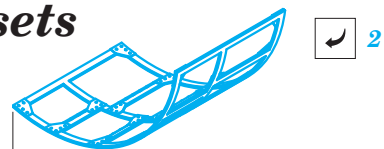

For further detail sets look for **eduard** 32 781 F4U-1 Birdcage interior
(not included in this set)

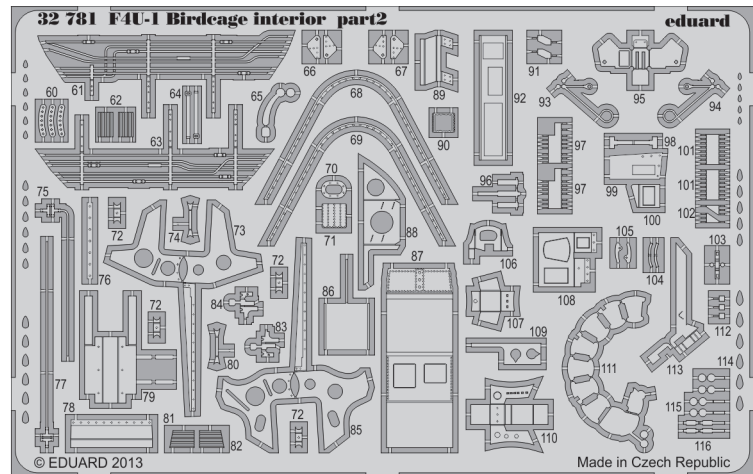
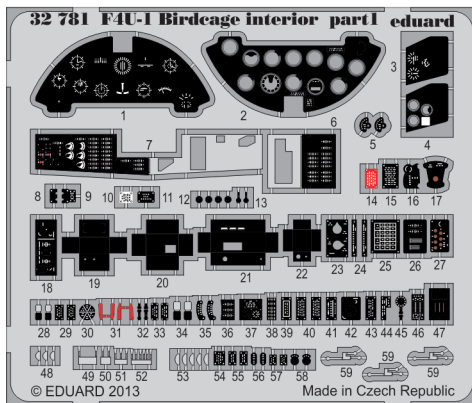

For further detail sets look for **eduard** 32 344 F4U-1 Birdcage exterior
(not included in this set)

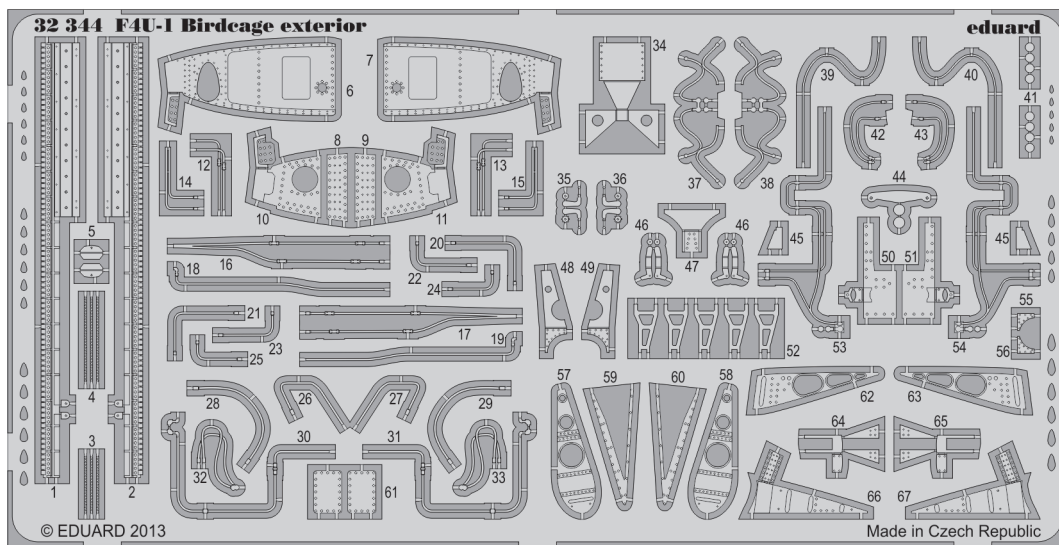

For further detail sets look for **eduard** 32 795 F4U-1 placards
(not included in this set)

